

# 800 SERIES

## *call system*

### 10-90 ZONE STANDARD INDICATOR PANEL

---

### WIRING AND INSTALLATION MANUAL

This document provides wiring and installation information for an 800 Series standard call system using a 'K' Range 10-90 standard panel as the central control and indicating equipment.

Information on our smaller 800 Series control panels (covering 1, 4 or 8 zones) and our emergency (two call levels) system is available from your supplier.

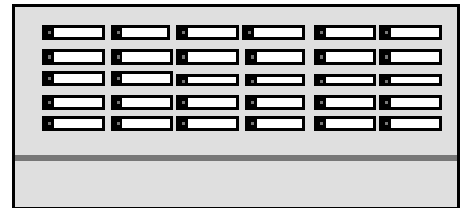

This equipment must only be installed and maintained by a suitably skilled and technically competent person. **THIS EQUIPMENT IS A PIECE OF CLASS 1 EQUIPMENT AND MUST BE EARTHED.**

All wiring should be provided in accordance with the current edition of the IEE Wiring Regulations, 16th Ed (BS7671 1993). Other national standards of installation should be used where applicable.

These instructions are general and cannot be considered to cover every aspect of call system installation.

No responsibility can be accepted by the manufacturers or distributors of this equipment for any misinterpretation of an instruction or guidance note or for the compliance of the system as a whole.

The manufacturers policy is one of continuous improvement and we reserve the right to alter product specifications at our discretion and without prior notice.

## DEFINITIONS

*Call points* are used to make a call and should be installed in all relevant areas. A variety of call points are available, examples of which are shown on the typical applications diagram on page 3. Throughout this document the term call point also encompasses door monitoring points and water resistant alert points.

Each light on a panel indicates a separate *zone*. A *zone* is usually one room and can contain several call points.

An *area* is a group of zones connected so as to operate a light whenever any zone calls.

A *call* is a signal made by any call point.

A call is *reset* using a magnetic reset key or by pressing a button at the calling room.

*Master reset* buttons cancel all calls on the system (note, these are not normally allowed on nursecall-type systems).

Magnetic call points and reset points must be reset using NC803M reset keys.

## GENERAL

Call points and ceiling pulls use similar electronics and can be wired on one zone.

Ceiling pulls, infra-red ceiling receivers and call latch modules need a separate reset point.

One master and up to three repeater panels can be connected and all inter-panel connections are in parallel.

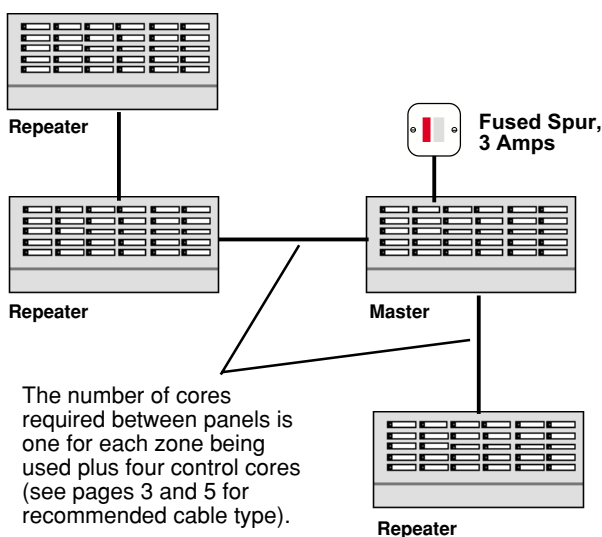

Call points etc., do not need to be connected directly to the master panel and can be wired to the most convenient repeater panel (if fitted).

Up to three sounders can be connected to *each* panel.

A set of auxiliary relay contacts in each panel operate when there is a call.

A 230 Va.c. to 12 Vd.c 250 mA power supply is fitted in master panels.

A 12 Volt 1.9 AHr sealed lead-acid battery may fitted for standby use.

## THE INDICATOR PANEL

All indicator panels must be sited internally in an area not subject to conditions likely to affect their performance, such as damp, salt-air, water ingress, extremes of temperature, physical abuse, etc. A central location for the master panel will help reduce voltage drop but panels can be located anywhere.

Panels should be sited at a height where they are easily accessible by their intended user(s) and their ambient light and sound levels should allow the status of their indicators and internal beepers to be clearly seen/heard. Ideally, the indicators on the front of the enclosure should be at eye level.

### Mains wiring

The requirement for the mains supply to the indicator panel is fixed wiring, using suitable three core cable (no less than  $0.75\text{mm}^2$  and no more than  $2.5\text{mm}^2$ ) or a suitable three conductor system that meets the appropriate national wiring regulations.

The panel should be fed from an isolating switched fused spur, fused at 3A. This should be secure from unauthorised operation and be marked 'CALL SYSTEM: DO NOT SWITCH OFF'. The mains supply must be exclusive to the indicator panel.

(As an alternative to a switched fused spur, a double pole isolating device may be used (see diagram below) providing it meets the appropriate national wiring regulations).

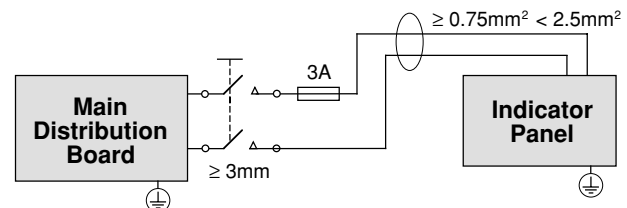

### Low voltage zonal wiring

All system wiring must be carefully planned before starting the job.

Refer to pages 3 and 4 for examples of zonal wiring and the type of cable required. Plan and route the wiring as indicated below (the dotted lines show the preferred wiring routes for all external wiring). Always segregate low voltage wiring from mains wiring. All external wiring brought into the panel should be adequately insulated with PVC or Neoprene.

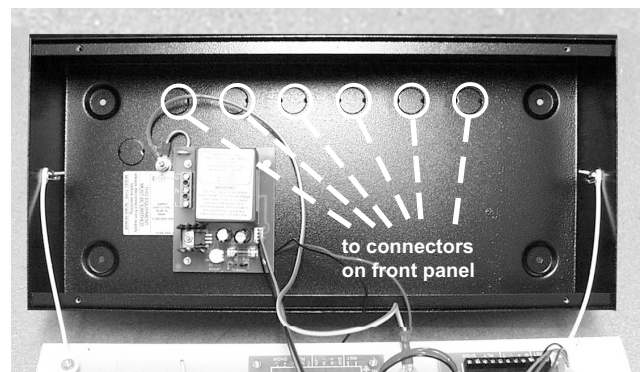

# TYPICAL STANDARD SYSTEM WIRING OVERVIEW & APPLICATIONS

The diagram below shows typical 800 Series standard call system applications together with cabling information. The system is highly flexible and devices can be mixed to meet the call communication requirements of virtually any building.

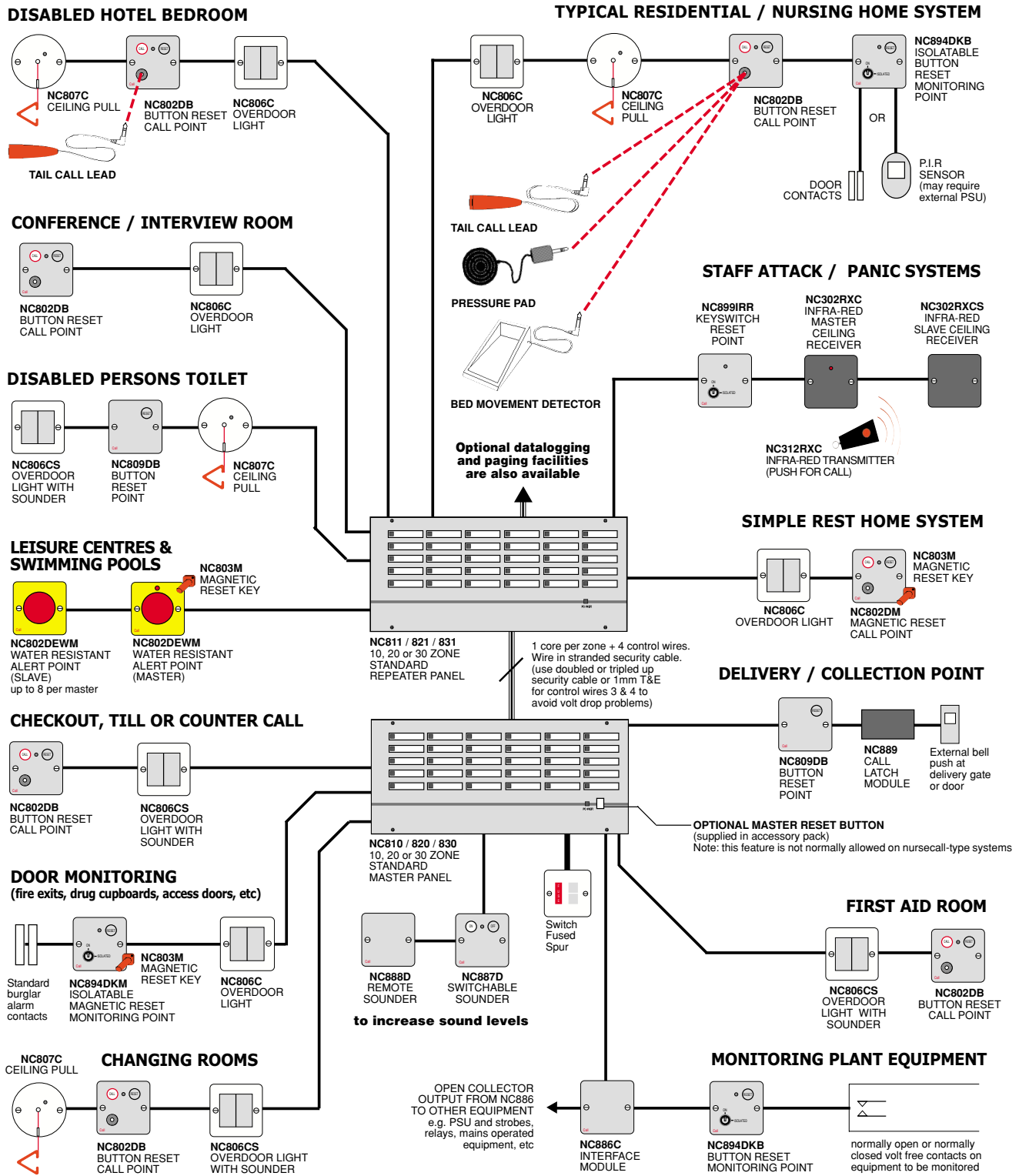

## 800 SERIES STANDARD (ONE CALL LEVEL) SYSTEM : CABLE TYPES & WIRING REQUIREMENTS

### EXTRA LOW VOLTAGE STRANDED (7/0.2) SECURITY CABLE

- Typically 4 or 6 core dependent on layout and devices used
- Multi-core cable can be used to reduce wiring runs but more joints will result
- DO NOT use solid core cable as it breaks easily
- We strongly recommend you leave about 20-25% spare cores in each cable run
- See right and page four for cores required per device

230 Va.c. MAINS FEED, e.g. 1mm T&E

OTHER (as specified)

### Panels

Run 1 core per zone plus 4 control wires between panels.

### Sounders

Run 1 core plus 1 or 2 common cores to the nearest panel.

### Call points

Run 1 signal wire per zone plus a common negative to the nearest panel.

### Overdoor lights

Connect to the signal wire of the zone being indicated and to common negative and common positive.

## DETAILED DEVICE AND ZONE WIRING

### Sounder wiring

Remote sounders need two connections, a sndr positive from the nearest panel and a common negative. Up to 3 can be connected to each panel.

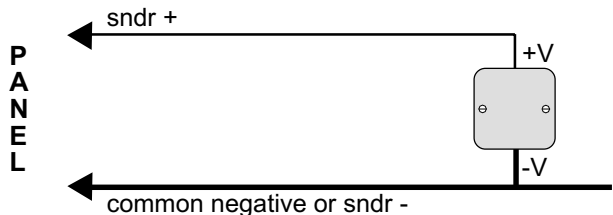

Switchable sounders also need a common positive.

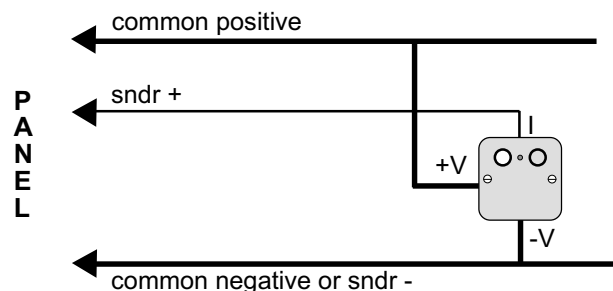

Up to three remote sounders may be activated by a switchable sounder.

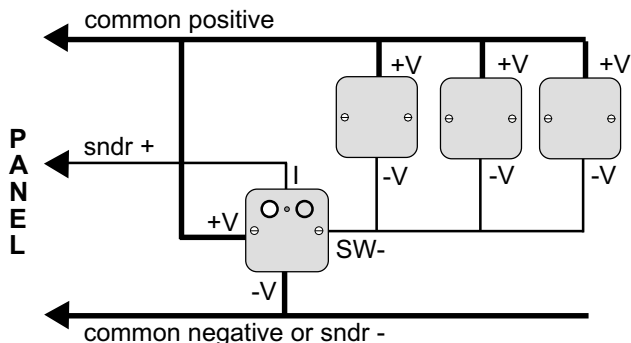

### Zone wiring

Signal wires from call points connect to any terminal A to J at the nearest panel (for termination details see page 5)

#### Call points, ceiling pulls & resets

A call point connects to a common negative and a signal wire

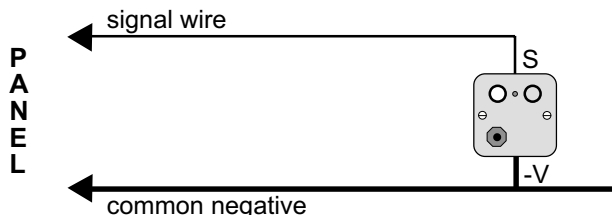

Any number of call points can be connected to one zone but if more than one calls at once only the last will hold the call. The other call points will reset automatically.

A ceiling pull (in areas such as en-suite bathrooms) can be reset at any magnetic or button reset call point.

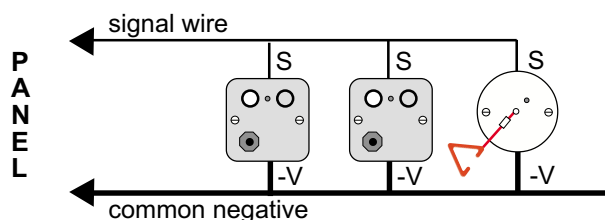

A ceiling pull can also be reset at a reset point.

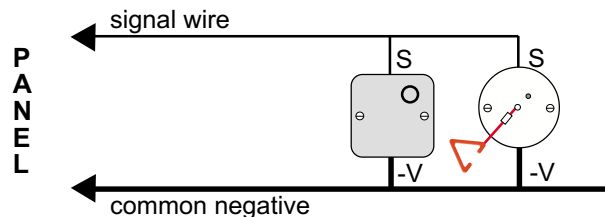

Several ceiling pulls on the same zone can be reset at one reset point.

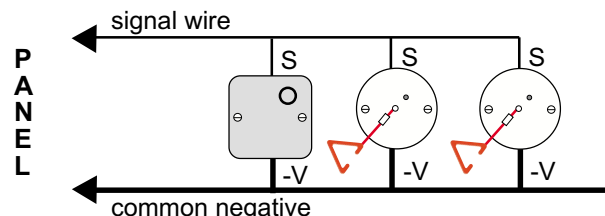

### Overdoor lights

Overdoor lights connect to common negative, common positive, and the signal wire of the zone they indicate. Two typical zone configurations are shown below:

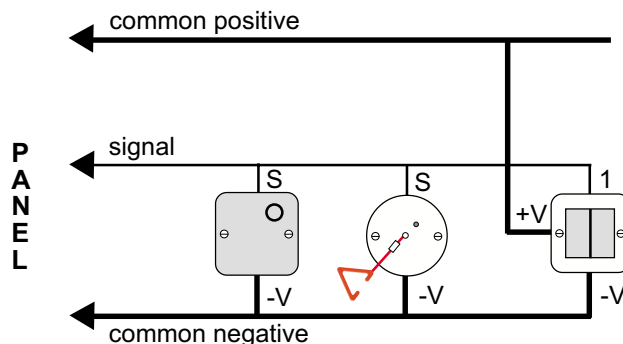
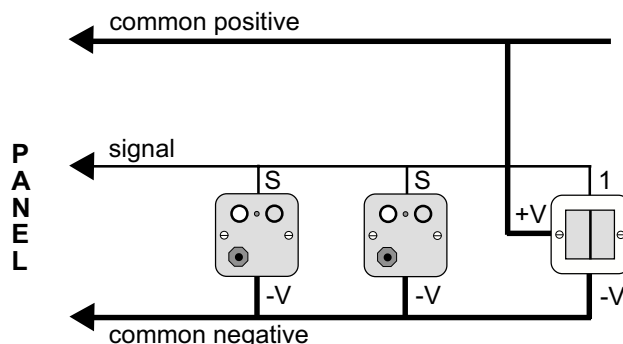

## FIRST FIX

**Panels :** The panel must be securely fixed to a wall, using the mounting holes provided. The mounting holes are suitable for use with No. 8 round head or countersunk woodscrews. Assess the condition and construction of the wall and use a suitable screw fixing. Any dust created during the fixing process must be kept out of the electrical and electronic systems and care must be taken not to damage any wiring or components.

**Call Points :** Use 25mm square cornered, single gang boxes for all wall mounted accessories (Water Resistant Alert Points are designed to be surface mounted). In care facilities, mount call points above final bedhead height to prevent damage to tail call leads when beds are moved.

**Other devices:** Call latch modules and input expanders are small sealed units with self adhesive fixing and wire termination. Mount them in any suitable box.

## SECOND FIX

### Connecting mains to the master indicator panel.

The general requirement for the mains supply to the master indicator panel is described on page 2. The earth, neutral and live connections should be made to the terminals marked  $\oplus$ , N and L respectively on the power supply PCB as shown below.

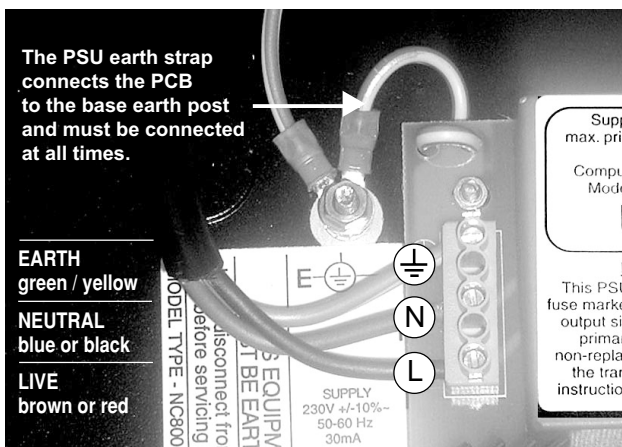

Before powering up, ensure the 4 way PSU loom is connected between PL1 on the power supply PCB to PL6 on the master indicator PCB (the board with the buzzer on). Connection to any other indicator panel connector may result in system malfunctions.

### Connecting the stand-by power supply.

For the emergency standby power supply, only a good quality 12V sealed lead acid battery should be used. The battery must be connected as shown below. Always be sure of the connections before you make them and position the battery in the panel as shown. Always dispose of used batteries according to the battery manufacturers instructions.

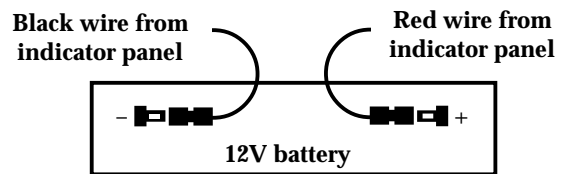

**IMPORTANT: ONLY USE THE FOLLOWING FUSE RATINGS**  
Fuse 2, output fuse F 1A L 20 x 5mm to IEC(EN60127 pt 2)

### Connecting call points, etc, to panels (example configuration only)

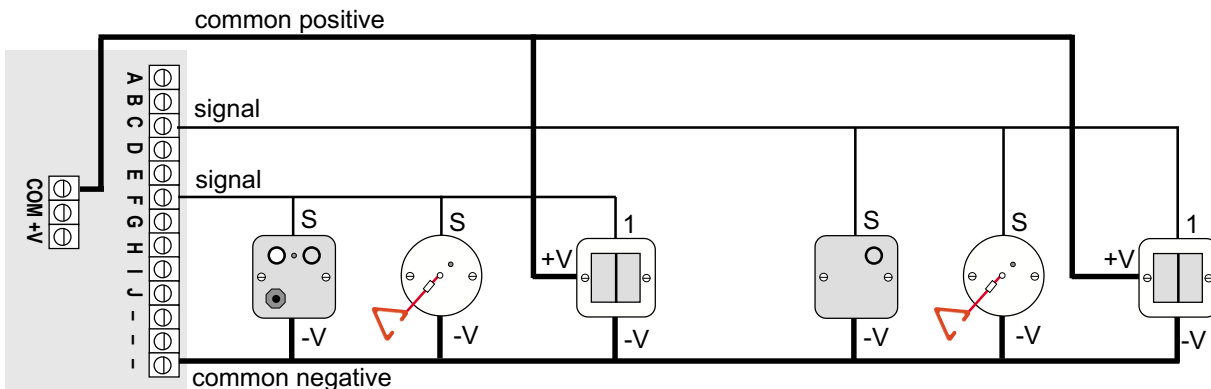

#### Control wires between panels

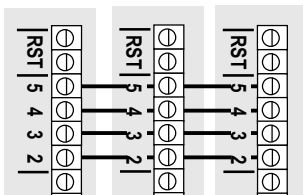

Control wires must be connected between the main boards in each panel (the PCB with the power light). Wire in stranded security cable (use doubled or tripled up security cable or 1mm T&E for control wires 3 & 4 to avoid volt drop problems)

#### Signal wires between panels

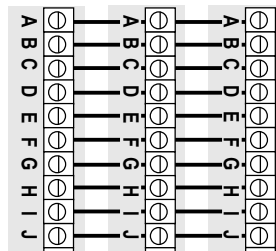

Make connections using stranded security alarm cable. Unused zones do not need to be connected.

#### Auxiliary relays and sounders

